

Solid Gold Performance for Combines, Hay Machines and Windrowers



The GOLD'n Rule in Cutting Systems

Gold Guards...

Out in the field where you need hard nosed, plug resistant guards that get the job done. Crary's exclusive full point/mini point design actually doubles the number of cutting surfaces for twice the cutting action in every sickle stroke. They also reduce plant side movement in half keeping shelling and shatter loss to the absolute minimum.

Sickle Sections...

The Bear Cut section utilizes a coarse serration that sharpens it's self as wearing occurs. All sickle sections offer bolt-on convenience and are heat treated for superior wear life.

Hold Downs...

Put the spring back into your cutting system. Any cutting system performs best when well adjusted. Only Crary's Gold n' Cut offers spring loaded adjustable hold downs as a standard feature on combine and hay cutting systems. This innovative feature adjusts pressure with the turn of a bolt, allowing you to maintain uniform hold down pressure while operating a free flowing sickle. Replaceable nylon wear pads offer 3-4 times the life to the hold downs.

ThunderBolt Sickle...

Crary's piece by piece design lets you build the exact sickle bar length you need. Easy to assemble interlocking/overlapping bar bolts together for greater convenience.

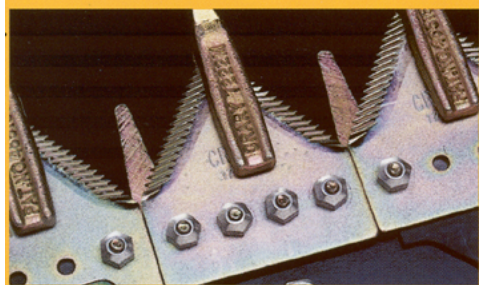
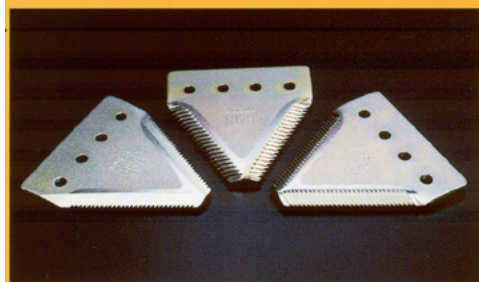
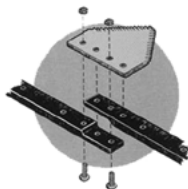

Call and order your new cutting system today!

1-800-548-6633

Crary Gold'n Cut Systems

If you don't see your combine listed, give us a call. The entire Crary product line is available.



Gold 'n Cut Kits to fit AGCO-Allis (Gleaner) Series 3-8 Also Massey 9850 Flex

ORDER NO.	DESCRIPTION	STOCK	RETAIL
K19294	Gold 'n Cut kit, 15'.	004684	\$1,080.00
K19295	Gold 'n Cut kit, 16'.	000889	\$1,100.00
K19296	Gold 'n Cut kit, 18'.	0000014	\$1,250.00
K19297	Gold 'n Cut kit, 20'.	0008013	\$1,350.00
K24075	Gold 'n Cut kit, 25'.	0000416	\$1,750.00
K19301	Gold 'n Cut kit, 30'.	0002717	\$2,150.00

Gold 'n Cut Kits to fit Case-IH 1020 series heads

ORDER NO.	DESCRIPTION	STOCK	RETAIL
K19925	Gold 'n Cut kit, 15'.	004685	\$1,080.00
K19927	Gold 'n Cut kit, 17.5'.	002594	\$1,190.00
K19928	Gold 'n Cut kit, 20'.	0008013	\$1,350.00
K19930	Gold 'n Cut kit, 25'.	0000416	\$1,750.00
K19931	Gold 'n Cut kit, 30'.	0002717	\$2,150.00
H15-0090	Drive head for Case-IH 1020 with a 3" cutting system.	03098	\$129.00

Please keep in mind, when you are switching from an 1 1/2" system on a Case-IH 1020 to a Gold 'n Cut, you will need a drive head for the 3" cutting system.

Gold 'n Cut Kits to fit Case-IH 820 series heads

ORDER NO.	DESCRIPTION	STOCK	RETAIL
K19456	Gold 'n Cut kit, 15'.	004685	\$1,080.00
K19457	Gold 'n Cut kit, 17.5'.	002594	\$1,190.00
K19458	Gold 'n Cut kit, 20'.	0008013	\$1,350.00

Gold 'n Cut Kits to fit Hart Carter Gen II series floating heads

ORDER NO.	DESCRIPTION	STOCK	RETAIL
K19839	Gold 'n Cut kit, 15'.	004684	\$1,080.00
K19840	Gold 'n Cut kit, 16'.	000889	\$1,100.00
K19425	Gold 'n Cut kit, 18'.	0000014	\$1,250.00
K19841	Gold 'n Cut kit, 20'.	0008013	\$1,350.00

Gold 'n Cut Kits to fit J.E. Love series floating heads

ORDER NO.	DESCRIPTION	STOCK	RETAIL
K19477	Gold 'n Cut kit, 15'.	004684	\$1,080.00
K19478	Gold 'n Cut kit, 16'.	000889	\$1,100.00
K19479	Gold 'n Cut kit, 18'.	0000014	\$1,250.00
K19480	Gold 'n Cut kit, 20'.	0008013	\$1,350.00

Gold 'n Cut Kits to fit John Deere 200/900 series heads

ORDER NO.	DESCRIPTION	STOCK	RETAIL
K19389	Gold 'n Cut kit, JD 215.	004685	\$1,080.00
K28086	Gold 'n Cut kit, JD 915.	004684	\$1,080.00
K19390	Gold 'n Cut kit, JD 216.	000889	\$1,100.00
K19391	Gold 'n Cut kit, JD 18'.	0000014	\$1,250.00
K19392	Gold 'n Cut kit, JD 20'.	0008013	\$1,350.00
K28779	Gold 'n Cut kit, JD 25'.	0000416	\$1,750.00
K19395	Gold 'n Cut kit, JD 30'.	0002717	\$2,150.00

Gold 'n Cut Kits to fit John Deere 600 series heads

ORDER NO.	DESCRIPTION	STOCK	RETAIL
K27457	Gold 'n Cut kit, JD 620.	0008013	\$1,350.00
K27459	Gold 'n Cut kit, JD 625.	0000416	\$1,750.00
K27460	Gold 'n Cut kit, JD 630.	0002717	\$2,150.00
K27461	Gold 'n Cut kit, JD 635.	0008819	\$2,350.00

Gold 'n Cut Kits to fit New Holland 973 Double Drive

ORDER NO.	DESCRIPTION	STOCK	RETAIL
K23655	Gold 'n Cut kit, 20'.	0008013	\$1,350.00
K23892	Gold 'n Cut kit, 25'.	0000416	\$1,750.00
K23676	Gold 'n Cut kit, 30'.	0002717	\$2,150.00

Gold 'n Cut Kits to fit New Holland 973 Single Drive

ORDER NO.	DESCRIPTION	STOCK	RETAIL
K23653	Gold 'n Cut kit, 15'.	004684	\$1,080.00
K23654	Gold 'n Cut kit, 16'.	000889	\$1,100.00
K24897	Gold 'n Cut kit, 18'.	0000014	\$1,250.00
K23887	Gold 'n Cut kit, 20'.	0008013	\$1,350.00



Parts for Crary Gold 'N Cut & King Kut Systems

Crary Gold 'n Cut Replacement Guards (CR7222, CR7228, CR7229 not made by Crary)

ORDER NO.	DESCRIPTION	STOCK	RETAIL
CR7222	Guard, fits John Deere 200, 600, 900 series, Agco series 2-8, NH960 rigid, and others..	23415	\$17.90
CR7225	Guard, fits J.E. Love, and Hart Carter Gen. 2 & 3.	23413	\$17.90
CR7228	Guard, fits hay machines and NH 970-973, Case-IH 820 / 1020 without wear plates, MacDon, Hesston, John Deere mowers.	23411	\$17.90
CR7229	Guard, Case-IH 820, 1020, (with wear plates) & MF 9100 Flex headers.	23414	\$17.90
CR22063	Guard, for head area on Case-IH, NH flex, and some hay machines.	06327	\$29.50
CR22064	Head guard for HC Gen II.	02126	\$26.50
CR21228	Guard, 3 point for John Deere 200 / 900 series.	00437	\$42.50
CR21549	3 point guard for HCC & Love.	08634	\$46.00
CR21579	Center guard for NH double drive flex heads.	02353	\$66.50
CR22659	Single point guard used on HCC Gen 3 and some IH hay machines.	02511	\$19.00
CR24361	End guard for Case-IH combines.	04411	\$18.00
CR22827	Center guard for NH haybines with double drive.	06534	\$44.50
CR29295-12	Guard to fit the head area on a John Deere 600 series.	02915	\$24.00



CR7222

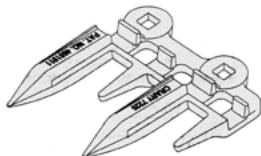

CR7225



CR7228

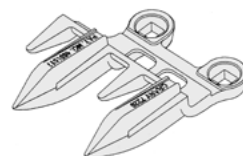

CR7229

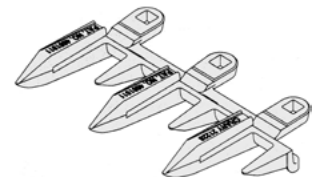

CR21228

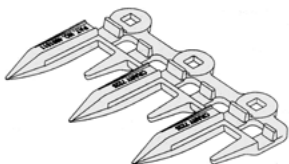

CR21549



CR21579



CR22063

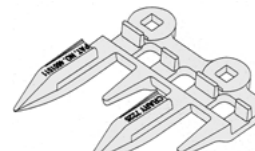

CR22064

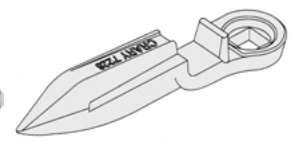

CR22659

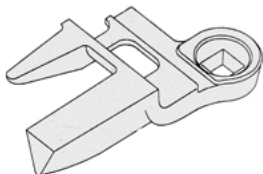

CR24361

Crary Gold 'n Cut and King Kut Sections

Sickle Sections...

The Bear Cut section utilizes a coarse serration that sharpens it's self as wearing occurs. All sickle sections offer bolt-on convenience and are heat treated for superior wear life.

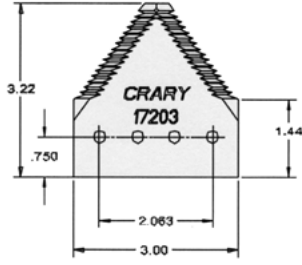
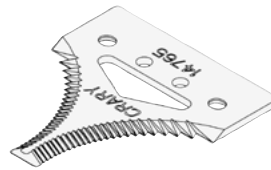

CR17206



ORDER NO.	DESCRIPTION	STOCK	RETAIL
CR14765	Section, King Kut - NEW!!! Fits JD, Agco, C-IH and others. (packed 10 per carton)	2915	\$2.40
CR17201	Section, C-IH, NH, others. (packed 10 per carton)	0214	\$1.50
CR17202	Section, MF, JD 600 series, others. (packed 10 per carton)	0214	\$1.50
CR17203	Section, JD, others. (packed 10 per carton)	0214	\$1.50
CR17204	Section. (packed 10 per carton)	0214	\$1.50
CR17205	Section, HC (OEM) (packed 10 per carton)	0215	\$1.50
CR17206	Section, Love, HC (with Crary) (packed 10 per carton)	0214	\$1.50
CR17318	Section, Allis series 2-8 (with Crary) (packed 10 per carton)	0218	\$1.50
CR17420	Section, ctsk bottom, NH DD. (packed 10 per carton)	0029	\$2.50
CR17424	Section, ctsk top, NH DD. (packed 10 per carton)	6338	\$4.20
CR16009	Section, overlap, NH. (packed 10 per carton)	2743	\$5.90
CR21553	Half Section, JD LH. (packed 10 per carton)	6523	\$3.20
CR21554	Half Section, JD RH. (packed 10 per carton)	6524	\$3.20
CR22526	Half Section, C-IH LH. (packed 10 per carton)	6521	\$3.20
CR17428	Overlap strap, NH.	08613	\$21.00
KDC55	Pkg of 50 splined section bolts and nuts. 5/8" long.	8468	\$9.26
KDC5501	Pkg of 25 splined section bolts and nuts. 1" long.	8748	\$6.83

Crary Wear Plates and Hold Down Plates

ORDER NO.	DESCRIPTION	STOCK	RETAIL
SDC468	Wear Plate, universal, 6".	3318	\$1.90
CR24261	Wear Plate, Case-IH 1020 with 7229 guards.	0232	\$4.00
CR16658	Wear Plate, universal, 12".	6141	\$5.20
CR23621	Hold down plate for New Holland flex heads - short.	2554	\$6.90
CR23652	Hold down plate for New Holland flex heads - long.	2958	\$7.40



SDC468

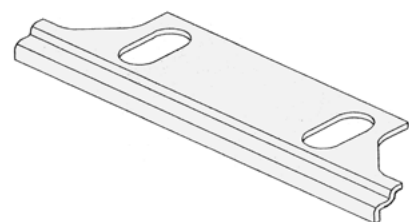

CR24261

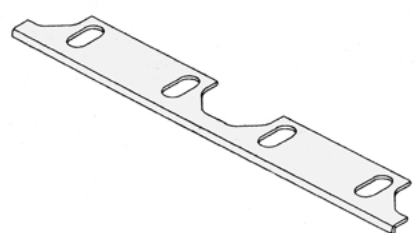

CR16658

Crary Gold 'n Cut Hold Downs

Hold Downs...

Put the spring back into your cutting system. Any cutting system performs best when well adjusted. Only Crary's Gold n' Cut offers spring loaded adjustable hold downs as a standard feature on combine and hay cutting systems. This innovative feature adjusts pressure with the turn of a bolt, allowing you to maintain uniform hold down pressure while operating a free flowing sickle. Replaceable nylon wear pads offer 3-4 times the life to the hold downs.

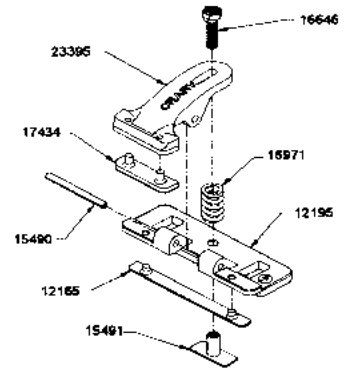

ORDER NO.	DESCRIPTION	STOCK	RETAIL
CR25615	HD for CIH 1020 with Crary using CR7229 guards.	02019	\$12.75
CR24344	HD for John Deere 200, 600, 900 series., Agco-Allis 2-8.	02018	\$12.75
CR24335	HD for CIH 1020 with OEM 3", IH820.	02011	\$12.75
CR24338	HD for CIH 1020 with Crary 7228 guards, most hay systems and also for MacDon, NH 970-973.	02011	\$12.75
CR24911	HD for drive head area, IH 820, JD 200, 900, Love.	29115	\$14.90
CR25348	HD for head area on CIH 1020 using CR7229 guards.	29114	\$14.90
CR25454	HD for head area on CIH 1020 using CR7228 guards.	29118	\$14.90
CR24351	HD for Hart Carter & Love.	02011	\$12.75
CR17418	Non spring loaded hold down for HCC drive head area.	08823	\$36.00

Replacement Parts for Spring Loaded Hold Downs

Front Wear Pads



ORDER NO.	DESCRIPTION	STOCK	RETAIL
CR17434	Front Wear Pad, thin. (used on Crary hold down numbers 24344, 24911, 24338, 25724, 24335, 25347)	0011	\$1.25
CR12848-00	Front Wear Pad, medium. (25615, 25454, 25453)	0011	\$1.25
CR17435	Front Wear Pad, thick. (24351, 24337)	0017	\$1.25

Rear Wear Pads



ORDER NO.	DESCRIPTION	STOCK	RETAIL
CR12156	Rear Wear Pad,. (24337, 25615, 25347)	0011	\$1.25
CR12165	Rear Wear Pad. (24335,24344, 25454, 24911, 25348)	0011	\$1.25
CR12166	Rear Wear Pad. (24336, 24338, 25724)	0017	\$1.25

Crary Gold 'n Cut Thunderbolt Sickles

ThunderBolt Sickle...

Crary's piece by piece design lets you build the exact sickle bar length you need. Easy to assemble interlocking/overlapping bar bolts together for greater convenience. Drive head is sold seperately.

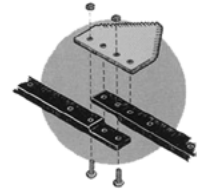

ORDER NO.	DESCRIPTION	STOCK	RETAIL
CR19359	John Deere Sickle, 215. <i>(Also works with OEM guards)</i>	002918	\$240.00
CR28084	John Deere Sickle, 915 <i>(Also works with OEM guards)</i>	002917	\$240.00
CR19360	John Deere Sickle, 16' <i>(Also works with OEM guards)</i>	008021	\$260.00
CR19361	John Deere Sickle, 18' <i>(Also works with OEM guards)</i>	000426	\$300.00
CR19362	John Deere Sickle, 20' <i>(Also works with OEM guards)</i>	004628	\$330.00
CR28777	John Deere Sickle, 25' <i>(Also works with OEM guards)</i>	002336	\$415.00
CR19365	John Deere Sickle, 30' <i>(Also works with OEM guards)</i>	008638	\$460.00
CR19911	Case-IH 1020, 17.5' <i>(Also works with OEM guards)</i>	002321	\$290.00
CR19912	Case-IH 1020, 20' <i>(Also works with OEM guards)</i>	004628	\$330.00
CR19913	Case-IH 1020, 22.5' <i>(Also works with OEM guards)</i>	006927	\$370.00
CR19914	Case-IH 1020, 25' <i>(Also works with OEM guards)</i>	002339	\$415.00
CR19915	Case-IH 1020, 30' <i>(Also works with OEM guards)</i>	000638	\$450.00
CR19449	Case-IH 820, 17.5'. <i>(Also works with OEM guards)</i>	002321	\$290.00
CR19450	Case-IH 820, 20' <i>(Also works with OEM guards)</i>	004628	\$330.00
CR19543	Case-IH 820, 22.5' <i>(Also works with OEM guards)</i>	002137	\$390.00
CR19265	Agco-Gleaner 20'.	004629	\$330.00
CR24073	Agco-Gleaner 25'.	002333	\$415.00
CR19269	Agco-Gleaner 30'.	000633	\$450.00
CR19463	Love floating bar, 15'	000022	\$250.00
CR19464	Love floating bar, 16'	006124	\$270.00
CR19466	Love floating bar, 20'	002722	\$340.00
CR19824	New Holland Double Dr. 20' <i>(Also works with OEM guards)</i>	004628	\$330.00
CR23890	New Holland Double Dr. 25' <i>(Also works with OEM guards)</i>	002333	\$415.00
CR19975	New Holland Double Dr. 30' <i>(Also works with OEM guards)</i>	000631	\$450.00
CR19405	Hart Carter Gen III sickle that is using CR7225 guards, 15'.	000022	\$250.00
CR19408	Hart Carter Gen III sickle that is using CR7225 guards, 20'.	002720	\$340.00
CR24776	New Holland Haybines, 9' <i>(Also works with OEM guards)</i>	004414	\$180.00
CR24759	JD Haybines, 1209, 1219, 9' <i>(Also works with OEM guards)</i>	004411	\$180.00
CR19615	New Holland hay machines, 7' sickle. <i>(Also works with OEM guards)</i>	002112	\$140.00

Replacement Sickle Segments for Crary Gold 'n Cut Sickles

John Deere 200/900 Series

ORDER NO.	DESCRIPTION	STOCK	RETAIL
CR28211	Left hand segment for a John Deere 200/900 series.	004218	\$155.00
CR28212	Center segment (8.5') for 18, 20, 22, 24, 25, 30 John Deere 200/900 series.	004217	\$155.00
CR28218	Right hand segment on John Deere 13'.	04084	\$100.50
CR28215	Right hand segment on John Deere 215.	000018	\$125.00
CR28216	Right hand segment on John Deere 915.	004014	\$130.00
CR28213	7.5' Right hand segment on John Deere 16''.	000214	\$150.00
CR28220	Right hand segment on John Deere 18'.	00631	\$45.00
CR28219	Right hand segment on John Deere 20'.	00068	\$75.00
CR28217	Right hand segment on John Deere 22'.	06589	\$107.00
CR28214	Right hand segment on John Deere 24'.	004014	\$130.00
CR28775	Right hand segment on John Deere 25'.	002115	\$140.00
CR28218	Right hand segment on John Deere 30'.	08089	\$101.00

Case-IH 1020 Series

ORDER NO.	DESCRIPTION	STOCK	RETAIL
CR28167	8.5' Left hand segment on all Case-IH 1020 series.	006318	\$170.00
CR28152	8.5' Center segment on Case-IH 1020 20', 22.5', 25', 30'.	006317	\$170.00
CR28171	Right hand segment on Case-IH 1020 15'.	000015	\$125.00
CR28170	8' Right hand segment on Case-IH 1020 16.5, 25'.	008215	\$160.00
CR28169	Right hand segment on Case-IH 1020 17.5'.	006318	\$170.00
CR28174	3' Right hand segment on Case-IH 1020 20'.	00465	\$80.00
CR28172	Right hand segment on Case-IH 1020 22.5'.	00298	\$115.00
CR28173	Right hand segment on Case-IH 1020 30'.	08089	\$101.00