

Sickles - Split sickle with bolted sections

ORDER NO.	DESCRIPTION	STOCK	RETAIL
CR19463	Sickle, 15' with "Big Tooth" sections.	000028	\$250.00
CR19464	Sickle, 16' with "Big Tooth" sections.	006124	\$270.00
CR19466	Sickle, 20' with "Big Tooth" sections.	002725	\$340.00

Sickle Bar Drive Head

ORDER NO.	DESCRIPTION	STOCK	RETAIL
DCLOVE	Drive head with stabilizer bar.	00240	\$60.00

Mower / Conditioner Parts



K231271

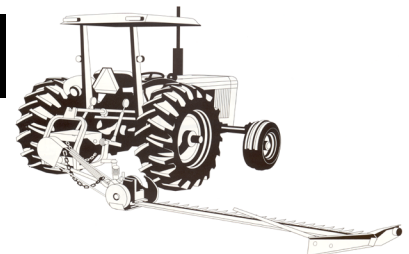

Sickle Sections

ORDER NO.	DESCRIPTION	STOCK	RETAIL
K211022 (25/box)	Section, underserrated, black, heavy section. Fits John Deere mowers and mower conditioners except 140, 160, 580, & 590. Fits all Ford mowers except model 505.	478	\$1.06
K212082 (25/box)	Section, underserrated, chrome, heavy section. Fits John Deere mowers and mower conditioners except 140, 160, 580, & 590. Fits all Ford mowers except model 505.	9218	\$1.84
K212241 (25/box)	Section, chrome, top serrated, extra heavy, "Big Tooth". Fits JD mowers and mower conditioners except 140, 160, 580, & 590. Fits all Ford mowers except model 505.	6118	\$1.66
K231271 (25/box)	Section, black, Big Tooth, extra heavy, top serrated. Fits Case-IH, Ford, New Holland, New Idea, Hesston, Gehl/Owatonna.	097	\$1.29

Bolts for Sections

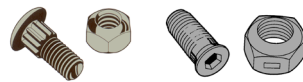

ORDER NO.	DESCRIPTION	STOCK	RETAIL
KDC55	Section bolts and nuts, 5/8" long, box of 50.	8465	\$9.26
KDC5501	Section bolts and nuts, 1" long, box of 25.	8744	\$6.83
KDC55114	Section bolts and nuts, 1-1/4" long, box of 25.	4253	\$7.50
K904525	Countersunk bolt and lock nut, 5/8" long. Box of 50.	0088	\$11.43
K904528	Countersunk bolt and lock nut, 1" long. Box of 50.	7958	\$8.53
KBDC174	Section bolts and nuts, 1/4" x 5/8", 50 pcs.	9874	\$11.25
KBDC174N	Section nuts, 1/4" self locking, 50 pcs.	5243	\$6.01

Wear Plates and Holddown Clips



SDC468



K5116



K800

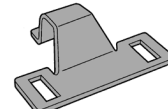

BDC5150H

ORDER NO.	DESCRIPTION	STOCK	RETAIL
SDC468	Steel wear plate, heat treated, fits all mowers and mower/conditioners.	3318	\$1.90
IDC468N	Nylon wear plate, fits all mowers and mower/conditioners. Reduces friction.	5016	\$1.50
K800	Hold down clip, steel, fits all single drive mowers and mower/conditioners. (515-066)	0928	\$4.14
K5116	Hold down clip, fits all John Deere mowers and haybines. For use with riveted or bolted sickles. (515-116).	9134	\$4.56
BDC5150H	High arch hold down clip for use at the drive head area.(515-126)	4636	\$5.20

Guards



ORDER NO.	DESCRIPTION	STOCK	RETAIL
BU107	Single prong guard, universal. Fits AC, Case, Deere, IHC, New Holland, Oliver, New Idea. - Replaces DM700	3847	\$6.90

BU210	Double prong guard. Fits Case-IH mower/conditioner models 170, 175, 200, 225, 816, 990, and others. Replace IH number 1326787C3, 483500R4, and 187346A1.	34015	\$14.90
-------	--	-------	---------



BU215	Double prong guard. Fits Case-IH 8300 series mower conditioners 525, 625, 8320, 8330, 8340, 8350, 8360, 8370, 8380, SC412, SC414 and SC416 windrowers 8210, 8220, 8230, 8240, 8820, 8830, 8840, DHX182, DHX212, DHX252, DHX302, DHX362, HDX121, HDX122, HDX141, HDX142, HDX161, HDX162, HDX181, HDX182, SCX100 and SMX91. Also all New Holland mower/conditioners, replaces NH no. 219191, 858778, and 86521587. Hesston mower conditioners 1109, 1110, 1120, 1130, 1150, 1160, 1170, 1260, 1265, 1270, 1275, 2270 and 2275; headers 8010, 8020, 8100, 8200, 8400, 9020, 9125, 9145.	7198	\$13.10
-------	--	------	---------



BU220	Double prong guard. Fits Deere mower models 37, 38, 39, 250, 350, 450 and mower conditioner models 480, 483, 485, 215, 215A, 780, 800, 880. Replaces Deere no. E48093 and E82559. Fits Gehl models 770, 880, 1070, 1090, replaces Gehl no. 072057. Uses plow bolts when mounting.	17018	\$15.30
-------	---	-------	---------



BU221	Double prong guard. Used on JD mower conditioner models 1207, 1209 and 1214. Also 1219 prior to s/n 710000. Replaces JD no's E62000 and E52667.	34018	\$14.90
-------	---	-------	---------



BU245	Double prong guard. Replaces Hesston no. 49239 and 700700845. Fits Gehl models 2130, 2160, 2230, 2262. Fits Case-IH models 8300 series, 8210, 8220, 8230, 8240, 8820, 8830. Also used on older New Holland.	7898	\$14.10
-------	---	------	---------



BU250	Double prong stub guard. Used on Case-IH, Gehl, Hesston, New Holland.	1399	\$13.30
-------	---	------	---------



BU270	Double prong guard. Fits Gehl MA206A, HK108, HK440, also Case-IH 100, 110, 115, 120, 1190, 1290, 1490, 1590, 75, 210, 230, 275, 375, 4000, 5000, 5500 also New Idea 507, 509, 512, 514, 5107, 5109, 5112, 5114.	51019	\$14.50
-------	---	-------	---------

Tie Guards

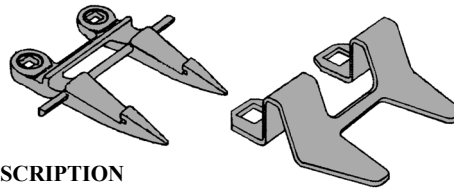

ORDER NO.	DESCRIPTION	STOCK	RETAIL
BT260	Tie guard, used on Case-IH, Gehl, Hesston, New Holland.	0892	\$14.00
BT262	Tie plate, high arch, used with BT260.	5950	\$8.50
BT261	Tie plate, low arch, used with BT260.	5131	\$4.50

Drive Heads

New Holland



ORDER NO.	REFERENCE	DESCRIPTION	STOCK	RETAIL
K901033	289488	Drive head, fits 474, 489.	66985	\$128.09
K901034	577866	Drive head, fits 495, 1495.	44874	\$112.06
K901051	134182	Drive head bushing, fits 460-469. (920-434)	15025	\$29.30
K901052	254132	Drive head bushing, fits 472, 479. (920-437)	00124	\$30.00
K901074	701401	Drive head bushing, fits 474, 489. (920-406)	08445	\$64.00

End Sections

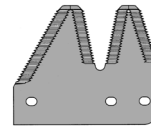

ORDER NO.	DESCRIPTION	STOCK	RETAIL
K612220	Blank end half section.	4931	\$5.63
K712730	Section and a half, 2 pcs. on card with rivets.	4785	\$12.49

Splice Kit for Sickles

KONDEX® LICKITY-SPLIT™

Sickle Repair Kits

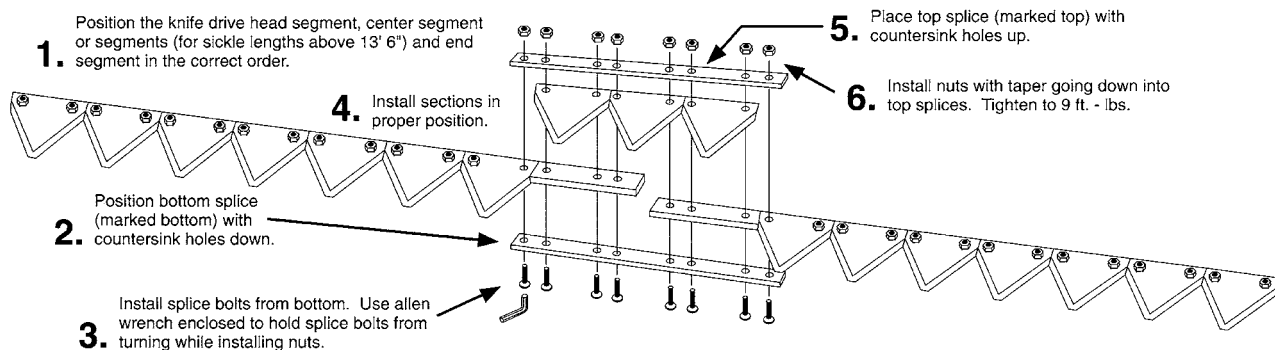

ORDER NO.	DESCRIPTION	WT.	STOCK	RETAIL
K711010	Repair kit for 7000 (2 1/16" centers) series sickles.	1	52918	\$27.50
K711012	Repair kit for 6000 (2" centers) series sickles.	1	71027	\$28.81

Disc & Drum Mower Components



A



B



C

Blades are sold by the piece.

Blades Bush Hog

ORDER NO.	STYLE	MODELS	SIZE	HOLE SIZE	HDWE	STOCK	RETAIL
527746 (RH)	C	DM5406, 07, 08, 09	4.72" x 1.89" x .16"	.89"	B4/N4	4011	\$1.49
527747 (LH)	C	DM5406, 07, 08, 09	4.72" x 1.89" x .16"	.89"	B4/N4	4015	\$1.49

Kuhn

ORDER NO.	STYLE	MODELS	SIZE	HOLE SIZE	HDWE	STOCK	RETAIL
55903210 (LH)	B	GMD400, 500, 600, 700, FC250, 300, & 350.	4.21" x 1.77" x .16"	.72"	B1/N2	677	\$1.29
55903310 (RH)	B	GMD400, 500, 600, 700, FC250, 300, & 350.	4.21" x 1.77" x .16"	.72"	B1/N2	672	\$1.29
56151210 (LH)	B	GMD44, 55, & 66 with standard disc.	3.74" x 1.77" x .14"	.64"	B2/N1	963	\$0.99
56151310 (RH)	B	GMD44, 55, & 66 with standard disc.	3.74" x 1.77" x .14"	.64"	B2/N1	965	\$0.99
56451200 (LH)	B	GMD44, 55, 66, & 77 with Heavy Duty disc.	4.84" x 1.77" x .16"	.72"	B1/N2	795	\$1.39
56451300 (RH)	B	GMD44, 55, 66, & 77 with Heavy Duty disc.	4.84" x 1.77" x .16"	.72"	B1/N2	796	\$1.39

Vicon

ORDER NO.	STYLE	MODELS	SIZE	HOLE SIZE	HDWE	STOCK	RETAIL
58699 (LH)	C	AM3200, CM165, 167, 240, 247, 1700, KM240, 241, 321, & 281 Early models with 2 blades per disc.	4.72" x 1.89" x .16"	.72"	B3/N3	799	\$1.39
58700 (RH)	C	AM3200, CM165, 167, 240, 247, 1700, KM240, 241, 321, & 281 Early models with 2 blades per disc.	4.72" x 1.89" x .16"	.72"	B3/N3	797	\$1.39
90261559 (LH)	C	AM2800, CM216, 217, 2200, & 281 late models with 3 blades per disc.	4.21" x 1.89" x .16"	.72"	B3/N3	092	\$1.29
90261560 (RH)	C	AM2800, CM216, 217, 2200, & 281 late models with 3 blades per disc.	4.21" x 1.89" x .16"	.72"	B3/N3	095	\$1.29

Krone

ORDER NO.	STYLE	MODELS	SIZE	HOLE SIZE	HDWE	STOCK	RETAIL
1398880 (LH)	C	323 shaft drive.	4.41" x 1.89" x .16"	.75"	-	987	\$1.27
1398890 (RH)	C	323 shaft drive.	4.41" x 1.89" x .16"	.75"	-	985	\$1.27

New Holland

ORDER NO.	STYLE	MODELS	SIZE	HOLE SIZE	HDWE	STOCK	RETAIL
9847683 (RH)	C	615, 616, 617, 1411, & 1431.	4.21" x 1.89" x .16"	.90"	Note A N5	094	\$1.29
9847684 (LH)	C	615, 616, 617, 1411, & 1431.	4.21" x 1.89" x .16"	.90"	Note A N5	097	\$1.29
55903210 (LH)	B	408, 412, 415, 411 s/n 711816 & up. Replaces NH no. 835820.	4.21" x 1.77" x .16"	.72"	Note A N2	097	\$1.29
55903310 (RH)	B	408, 412, 415, 411 s/n 711816 & up. Replaces NH no. 835819.	4.21" x 1.77" x .16"	.72"	Note A N2	092	\$1.29
56151210 (LH)	B	442, 452, & 462 with standard disc. Replaces NH no. 766726.	3.74" x 1.77" x .14"	.64"	B2/N1	963	\$0.99
56151310 (RH)	B	442, 452, & 462 with standard disc. Replaces NH no. 766727.	3.74" x 1.77" x .14"	.64"	B2/N1	965	\$0.99
56451200 (LH)	B	442, 452, 462, 463, & 465 with Heavy Duty disc. Replaces NH no. 784220.	4.84" x 1.77" x .16"	.72"	B1/N2	795	\$1.39
56451300 (RH)	B	442, 452, 462, 463, & 465 with Heavy Duty disc. Replaces NH no. 784221.	4.84" x 1.77" x .16"	.72"	B1/N2	796	\$1.39

Note A: Discs with lifters use B7; with out lifters use B6.

John Deere

ORDER NO.	STYLE	MODELS	SIZE	HOLE SIZE	HDWE	STOCK	RETAIL
56151210 (LH)	B	1320, 1326, 1327, 240, 260 with standard disc. Replaces JD no's. CC20500, CC4407.	3.74" x 1.77" x .14"	.64"	B2/N1	963	\$0.99
56151310 (RH)	B	1320, 1326, 1327, 240, 260 with standard disc. Replaces JD no's. CC20501, CC4406.	3.74" x 1.77" x .14"	.64"	B2/N1	965	\$0.99
56451200 (LH)	B	1320, 1326, 1327, 240, 260 with heavy duty disc. Replaces JD no's. CC21780, CC44005.	4.84" x 1.77" x .16"	.72"	B1/N2	795	\$1.39
56451300 (RH)	B	1320, 1326, 1327, 240, 260 with heavy duty disc. Replaces JD no's. CC21781, CC44004.	4.84" x 1.77" x .16"	.72"	B1/N2	796	\$1.39
55903210 (LH)	B	1350, 1360, 1460, 1470, 910, 920, 930. Replaces JD no's. CC26780, E80206.	4.21" x 1.77" x .16"	.72"	B1/N2	097	\$1.29
55903310 (RH)	B	1350, 1360, 1460, 1470, 910, 920, 930. Replaces JD no's. CC26781, E80208.	4.21" x 1.77" x .16"	.72"	B1/N2	092	\$1.29



A



B













C

Blades are sold by the piece.

Blades

Hardware for Disc & Drum Mower Blades

Packed & Priced in quantities of 6.

	ORDER NO.	MODELS	REFERENCE (HDWE COLUMN)	STOCK	RETAIL
	56115800	Kuhn, New Holland	B1 (Bolt)	3092	\$12.90
	56210100	Kuhn	B2 (Bolt)	4365	\$9.06
	81160	Vicon	B3 (Bolt)	2762	\$9.60
	527745	Bush Hog	B4 (Bolt)	8233	\$4.69
	527733	Bush Hog	B5 (Bolt)	8236	\$4.69
	86515925	New Holland	B6 (Bolt)	1433	\$4.87
	86515926	New Holland	B7 (Bolt)	6477	\$10.65
	80201052	Kuhn, New Holland	N1 (Nut)	6025	\$2.94
	80201262	Kuhn, New Holland	N2 (Nut)	0734	\$5.29
	30577100	Vicon	N3 (Nut)	079	\$1.00
	527495	Bush Hog	N4 (Nut)	35212	\$17.90
	86515265	New Holland	N5 (Nut)	38115	\$16.90